





VELOCITÀ ASCIUGATURA
DRYING TIME / TEMPS DE SÉCHAGE



RISPARMIO ENERGETICO
ENERGY SAVING / ÉPARGNE ENERGETIQUE



SILENZIOSITÀ
NOISELESS / SILENCIEUX



DESIGN



ANTIVANDALISMO
ANTIVANDALISM / ANTIVANDALISME



ECOSTREAM EcoFLOW

ECO-JET DRYERS

ASCIUGAMANI - HAND DRYERS - SÈCHE-MAINS



- 🇮🇹 - **67 VOLTE PIU' ECONOMICO**
 RISPETTO AI ROTOLI DI COTONE
- **52 VOLTE PIU' ECONOMICO**
 RISPETTO ALLA CARTA
- **7 VOLTE PIU' ECONOMICO**
 RISPETTO AGLI ASCIUGAMANI TRADIZIONALI
- 🇬🇧 - **67 TIMES BETTER**
 THAN COTTON DISPENSING RENT SERVICES
- **52 TIMES BETTER**
 THAN PAPER
- **7 TIMES BETTER**
 THAN TRADITIONAL HAND DRYERS
- 🇫🇷 - **67 FOIS MIEUX**
 QUE LE COTON
- **52 FOIS MIEUX**
 QUE LE PAPIER
- **7 FOIS PLUS EFFICACE**
 QUE LE SÈCHE-MAINS ÉLECTRIQUE TRADITIONNEL



MADE IN ITALY



GARANZIA 3 ANNI • WARRANTY 3 YEARS • GARANTIE 3 ANS



GUIDA ALLA SCELTA / HOW TO CHOOSE / COMMENT CHOISIR

1

 SCEGLI: CONO D'ARIA (ECOstream) o LAMA D'ARIA (ECOFlow)?



 CHOOSE: HOLE (ECOstream) OR BLADE (ECOFlow)?

 SELECTIONNER: CONE D'AIR (ECOstream) OU LAME D'AIR (ECOFlow)?

2

 SCEGLI IL MODELLO

 CHOOSE THE MODEL

 CHOISISSEZ LE MODÈLE

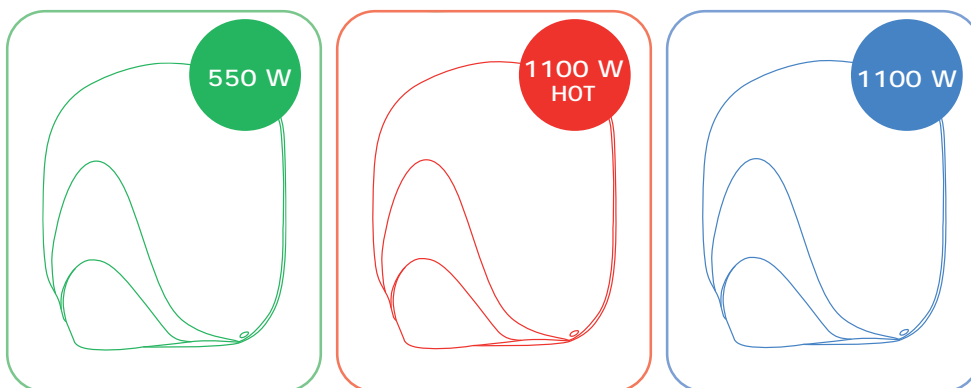

 ECOLOGICO: IL MAGGIOR RISPARGIO ENERGETICO

 ECO FRIENDLY: ENERGY EFFICIENT

 ECOLOGIQUE: ECONOMIE D'ÉNERGIE ABSOLUE

ARIA CALDA IMMEDIATA!
MOTORE 550 W +
RESISTENZA 550 W

IMMEDIATELY HOT AIR!
550 W MOTOR +
550 W HEATING ELEMENT

AIR CHAUD IMMÉDIATEMENT!
550 W MOTEUR +
550 W CHAUFFAGE

POTENZA ASSOLUTA:
IL PIÙ VELOCE

POWERFUL:
THE FASTEST ONE

PUISSANT:
LE PLUS RAPIDE

3

 SCEGLI LA COVER

 CHOOSE YOUR FAVOURITE COVER

 CHOISISSEZ VOTRE COUVERTURE FAVORITE



ABS bianco, automatico
white ABS, sensor operating
ABS blanc, capteur

alluminio bianco, automatico
white metal, sensor operating
metal blanc, capteur

alluminio satinato, automatico
satin metal, sensor operating
metal satin, capteur

alluminio cromato, automatico
chrome metal, sensor operating
metal chromé, capteur

EcoStream EcoFlow

ECO-JET DRYERS

ASCIUGAMANI - HAND DRYERS - SÈCHE-MAINS



550 W - 1100 W

TEMPO DI ASCIUGATURA: 10 - 15 sec - VELOCITA' ARIA 325 km/h (versione 1100 W)

IGIENE INTEGRATA

Il filtro EPA E11 (opzione) garantisce protezione contro oltre il 97,66 % di virus e batteri presenti nell'aria che viene utilizzata durante l'asciugatura.

RISPARMIO ENERGETICO ASSOLUTO: SOLO 2,3 W PER ASCIUGATURA (versione 550 W)

- oltre 52 volte più economico rispetto alla carta (550 W)
- 85 % - 90 % di risparmio rispetto ai modelli di asciugamani tradizionali

MOTORE STANDARD AC ALTA PRESSIONE

ASSENZA DI RESISTENZA ELETTRICA: riscaldamento dell'aria per compressione ed attraverso il calore dei motori, abbattendo i consumi e minimizzando i costi manutenzione.

DRYING TIME: 10 - 15 sec - AIR SPEED 325 km /h (1100 W version)

INTEGRATED HYGIENIC SYSTEM

EPA E11 filter (option) allows protection against 97,66 % of air viruses and bacterials, spreading clean air on hands.

ECOLOGICAL HAND DRYER, THE LOWEST POWER CONSUMPTION: ONLY 2,3 W per drying cycle (550 W version)

- SAVE 52 times than paper (550 W)
- SAVE 85 % - 90 % than traditional hand dryers

AC STANDARD MOTOR HIGH PRESSURE

NO HEATING ELEMENT: air heating through compression and engines warming, reducing energy consumption and minimizing maintenance costs.

TEMPS DE SÉCHAGE: 10 - 15 sec - VITESSE D'AIR 325 kilomètres par heure (Version 1100 W)

HYGIÈNE INTÉGRÉE

Le filtre EPA E11 (en option) offrant une protection de plus 97,66 % des virus et bactéries aéroportées qui est utilisée pendant le séchage.

ÉCONOMIE D'ÉNERGIE ABSOLUE: SEULEMENT 2,3 WATT POUR LE SÉCHAGE (Version 550 W)

- Plus de 52 fois d'économie par rapport au papier (550 W)
- 85 % - 90 % d'économie par rapport aux modèles traditionnels de sèche-mains

STANDARD MOTEUR AC HAUTE PRESSION

ABSENCE DE RÉSISTANCE ÉLECTRIQUE: chauffage de l'air grâce à la compression et à la chaleur des moteurs, ce qui réduit la consommation d'énergie et les coûts de maintenance.

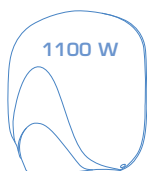

- NESSUNA RESISTENZA ELETTRICA: RISCALDAMENTO PROGRESSIVO CON L'UTILIZZO**
- NO HEATING ELEMENT: PROGRESSIVE AIR HEATING**
- ABSENCE DE RÉSISTANCE ÉLECTRIQUE: CHAUFFAGE AIR PROGRESSIF**



1100 W HOT

MODELLI CON RESISTENZA ELETTRICA 550 W + MOTORE 550 W, TOT. 1100 W

Perfetto equilibrio tra velocità di asciugatura / risparmio energetico / rumorosità
Il comfort dell'aria calda fin dal primo utilizzo, con un risparmio energetico eccezionale

MODELS WITH 550 W MOTOR + 550 W HEATING ELEMENT, TOT. 1100 W

Perfect balance between drying speed / energy efficient use / noise
Immediately warm air for a more comfortable drying experience, with exceptional power saving

MODÈLES AVEC CHAUFFAGE ELECTRIQUE 550 W + MOTEUR 550 W, TOT. 1100 W

L'équilibre parfait entre vitesse de séchage / économie d'énergie / bruit
Le confort de l'air chaud à partir de la première utilisation, avec économie d'énergie exceptionnelle

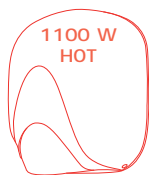

- ARIA CALDA IMMEDIATA!!!**
- IMMEDIATELY HOT AIR!!!**
- AIR CHAUD IMMEDIATEMENT!!!**



Il filtro EPA E11 (opzione) garantisce protezione contro il 97,66% di virus e batteri

EPA E11 filter (option) allow protection against 97,66% of viruses and bacteria

Le filtre EPA E11 (en option) Assure une protection contre 97,66% des virus et bactéries



COVER IN ALLUMINIO CON VERNICIATURA DI COLORE NERO METALLIZZATO, FINITURA GOFFRATA

DISPONIBILE PER TUTTE LE VERSIONI 550 - 1100 - 1100 HOT

METAL COVER, BLACK METALLIC PAINT, EMBOSSED FINISH

AVAILABLE FOR ALL VERSIONS 550 - 1100 - 1100 HOT



COVER EN METAL AVEC PEINTURE MÉTALLISÉE NOIRE, FINITION EN RELIEF

DISPONIBILE POUR TOUTES LES VERSIONS 550 - 1100 - 1100 HOT

EcoStream EcoFlow

ECO-JET DRYERS

ASCIUGAMANI - HAND DRYERS - SÈCHE-MAINS

-  ARTICOLI & CODICI PRODOTTO
-  MODEL REFERENCE CHART
-  TABLEAU DES MODÈLE DE RÉFÉRENCE



Cod.	Mod.			Cod.	Mod.		
EST ABS 550	ECOstream	ABS Bianco / White / Blanc	550W	EFL ABS 550	ECOflow	ABS Bianco / White / Blanc	550W
EST ABS 1100	ECOstream	ABS Bianco / White / Blanc	1100W	EFL ABS 1100	ECOflow	ABS Bianco / White / Blanc	1100W
EST BF 550	ECOstream	Metallo Bianco White metal / Metal blanc	550W	EFL BF 550	ECOflow	Metallo Bianco White metal / Metal blanc	550W
EST BF 1100	ECOstream	Metallo Bianco White metal / Metal blanc	1100W	EFL BF 1100	ECOflow	Metallo Bianco White metal / Metal blanc	1100W
EST LF 550	ECOstream	Metallo Cromato Chrome metal / Metal chromé	550W	EFL LF 550	ECOflow	Metallo Cromato Chrome metal / Metal chromé	550W
EST LF 1100	ECOstream	Metallo Cromato Chrome metal / Metal chromé	1100W	EFL LF 1100	ECOflow	Metallo Cromato Chrome metal / Metal chromé	1100W
EST SF 550	ECOstream	Metallo Satinato Satin metal / Metal satin	550W	EFL SF 550	ECOflow	Metallo Satinato Satin metal / Metal satin	550W
EST SF 1100	ECOstream	Metallo Satinato Satin metal / Metal satin	1100W	EFL SF 1100	ECOflow	Metallo Satinato Satin metal / Metal satin	1100W
EST NF 550	ECOstream	Metallo Nero Black metal / Metal noir	550W	EST NF 550	ECOflow	Metallo Nero Black metal / Metal noir	550W
EST NF 1100	ECOstream	Metallo Nero Black metal / Metal noir	1100W	EST NF 1100	ECOflow	Metallo Nero Black metal / Metal noir	1100W



Cod.	Mod.			Cod.	Mod.		
EST ABS 1100 HOT	ECOstream	ABS Bianco / White / Blanc	1100W	EFL ABS 1100 HOT	ECOflow	ABS Bianco / White / Blanc	1100W
EST BF 1100 HOT	ECOstream	Metallo Bianco White metal / Metal blanc	1100W	EFL BF 1100 HOT	ECOflow	Metallo Bianco White metal / Metal blanc	1100W
EST LF 1100 HOT	ECOstream	Metallo Cromato Chrome metal / Metal chromé	1100W	EFL LF 1100 HOT	ECOflow	Metallo Cromato Chrome metal / Metal chromé	1100W
EST SF 1100 HOT	ECOstream	Metallo Satinato Satin metal / Metal satin	1100W	EFL SF 1100 HOT	ECOflow	Metallo Satinato Satin metal / Metal satin	1100W
EST NF 1100 HOT	ECOstream	Metallo Nero Black metal / Metal noir	1100W	EFL NF 1100 HOT	ECOflow	Metallo Nero Black metal / Metal noir	1100W



OPZIONE FILTRO EPA E11 (TUTTI I MODELLI)
EPA E11 FILTER OPTION (ALL MODELS)
FILTRE EPA E11 EN OPTION (TOUS LES MODÈLES)

ASCIUGAMANI - HAND DRYERS- SÈCHE-MAINS

- CONFRONTO COSTI DI ASCIUGATURA ANNUALI
- ANNUAL SAVINGS CALCULATION
- CALCULEZ VOS COÛTS/ECONOMIES ANNUELLES

N° UTILIZZI GIORNALIERI DAILY USE UTILISATION PAR JOUR	ECOSTREAM ECOFLOW 1100W	ECOSTREAM ECOFLOW 550W	COTONE COTTON COTON	CARTA PAPER PAPIER	ASCIUGAMANI TRADIZIONALI 2400 W TRADITIONAL HAND DRYERS 2400 W SÈCHE-MAINS STANDARD 2400 W
100	€ 29,73/anno	€ 18,69/anno	€ 1.246,00	€ 1.094,80	€ 154,37
200	€ 59,46/anno	€ 37,38/anno	€ 2.492,00	€ 2.189,60	€ 308,74
400	€ 118,92/anno	€ 74,76/anno	€ 4.984,00	€ 4.379,20	€ 617,48



Calcoli basati su 365 giorni/anno. Costo dell'energia pari a € 0,2226/kWh. Costo salvietta di carta monouso pari a € 0,012 con una media di 2,5 salviette per asciugatura. Costo rotolo di cotone pari a 4 € (escluso canone dispenser), 120 asciugature per rotolo



Counts are based on 365 days per year. Energy cost € 0,2226/kWh. The average cost of a paper towel sheet is € 0,012 (2,5 paper towel sheets per user). The average cost of a cotton towel roll is € 4 (dispenser fee excluded, 120 dryings per roll).



Calculs basés sur 365 jours/an. Coût énergétique de 0,2226 € / kWh. Les serviettes en papier jetables coûtent 0,012 € avec une moyenne de 2,5 lingettes par séchage. Coût du rouleau de coton de 4 € (frais de location du distributeur exclus), 120 séchage par rouleau.

CARATTERISTICHE TECNICHE / TECHNICAL FEATURES / CARACTÉRISTIQUES TECHNIQUES

Funzionamento	Automatico
Functioning	Automatic
Activation	Automatique
Giri al minuto	
Tr min	30000 rpm (1100 W) - 26000 rpm (550 W)
Révolutions par minute	
Grado di protezione elettrica	
Electrical Protection Level	IP23 - CLASS II
Isolation électrique	
Tensione	
Supply Voltage	220 V-240 V
Tension d'alimentation	
Potenza totale	
Total power	1100 W - 550 W
Puissance totale	
Potenza resistenza	
Absorption Heating Element	550 W (solo - only - seule mod. HOT)
Puissance chauffage	
Potenza motore	
Absorption Motor	1100 W - 550 W
Puissance moteur	
Dimensioni A x L x P	
Dimensions H x W x D	285 X 221 X 157 mm
Dimensions H x L x P	
Frequenza	
Frequency	50-60 Hz
Fréquence	
Velocità aria	
Air Speed	325 km/h (1100 W) - 250 km/h (550 W)
Vitesse d'air	

Volume aria	
Air Flow	187 m ³ /h - 52 l/s (1100 W), 126 m ³ /h - 35 l/s (550 W)
Débit d'air	
Peso	
Weight	5,00 Kg (Metallo) - 3,00 Kg (ABS)
Poids net	
Materiale	ABS - Alluminio pressofuso
Materials	ABS - Die Cast Aluminium
Matériel	ABS - en fonte d'aluminium
Marchi di qualità	
Quality marks - certifications	CE
Certification	
Rumorosità (2 mt)	
Noise Level (2 mt)	80 db (1100 W) 75 db (550 W)
Niveau sonore (2 mt)	
Garanzia	3 anni*
Warranty	3 years*
Garantie	3 ans*

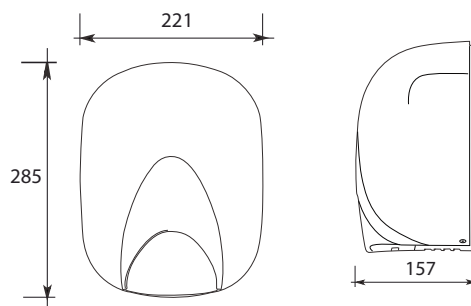

- * Per le limitazioni di garanzia si vedano le condizioni generali di servizio
- * Limited warranty. Please have a look to the General Warranty Conditions for details and consumables
- * Limitations de garantie: revoir Conditions de Garantie Generale